

## Features

- Pressure up to 10,000 psig (689 bar) @ 100°F (38°C).
- Temperature Rating up to 449°F (232°C) with standard PTFE packing; up to 1,200°F (648°C) with Grafoil packing.
- Standard 316 stainless steel, optional Alloy 400, and Alloy C276 construction.
- Valve stem back seating against the bevelled edge of bonnet in fully open position prevents maximum leakage through bonnet when packing fails.
- Standard non-rotating stem disc and stem packing below the threads design.

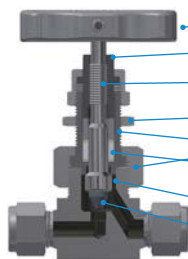

- **Handle**- Standard Stainless Steel formed handle, optional aluminum bar handle.
- **External Packing Bolt**- allows packing adjustment without the valve disassembly.
- **Roll threaded and hard chrome plated stem**- is for long valve life.
- **Panel Mounting Nut**- is standard and permits valve to panel or actuator.
- **Union Nut**- prevents accidental disassembly of the valve in service.
- **Stem Packing below the threads**- prevents media contamination and thread lubricant washout.
- **Stem Back Seating**- in fully open position.
- **Non-Rotating Stem Disc at Closure**- is for maximum metal seat life and positive seal.

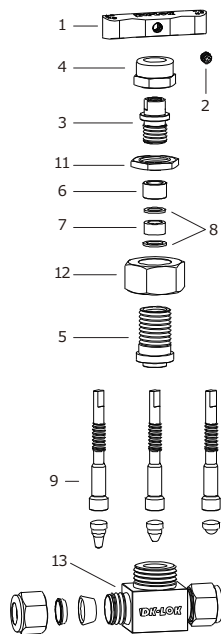

## Materials of Construction

Component	Valve Body Materials		
	SS316	Alloy 400	Alloy C276
	<b>Material Grade/ASTM Specification</b>		
1. Bar handle	Stainless Steel for V16, SS316/A276 for VH16, optional anodized aluminum handle		
2. Set screw	SS304		
3. Packing bolt	SS316/A276 or A479		
4. Cap nut	SS316/A276 or A479		
5. Bonnet	SS316/A276 or A479	Alloy 400/B164	C276/B574
6. Gland	SS316/A276 or A479	Alloy 400/B164	C276/B574
7. Packing (2)	PTFE/D1710, optional PEEK & Grafoil		
8. Packing supports (2)	SS316/A276 or A479	Alloy 400/B164	C276/B574
9. Stem	Hard Chrome-plated SS316/A276 or A479	Alloy 400/B164	C276/B574
10. Standard globe disc, optional globe ball & regulating disc.	TYPE630/A564	Alloy 400/B164	C276/B574
11. Panel nut	SS316		
12. Union nut	SS316/A276 or A479		
13. Body	SS316/A276 or A479	Alloy 400/B164	C276/B574

Wetted parts and lubricants are listed in blue.

**Lubrication :** • Nickel anti-seize lubricant (hydrocarbon carrier).  
• Ball disc: hydrocarbon-based.

## Technical Data

Ratings below are for valves with standard PTFE packing. Refer to valve ratings with optional packing on Page 4.

Valve Material	Stem Disc Designator	Temperature Rating °F(°C)	Pressure Rating @ -65 to 100°F (-53 to 38°C)
SS316 Alloy 400 Alloy C276	Globe: Nil. Regulating: -R Ball: -B	-65 to 450 (-53 to 232)	10,000 psig (689 bar)

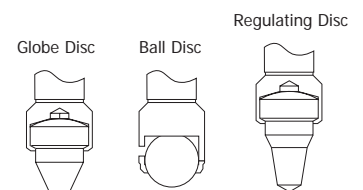

## Factory Test and Cleaning

Every valve is tested with the nitrogen gas @ 1,000 psig (68.9 bar) for leakage at the seat to a maximum allowable leak rate of 0.1 SCCM. The packing is tested for no detectable leakage. Optional hydrostatic shell test with additional cost is performed with pure water at 1.5 times the working pressure. Every valve is cleaned and packaged in accordance with DK-Lok cleaning standard DC-01.



**Ordering Information**

**VH16 Series (High Pressure)**

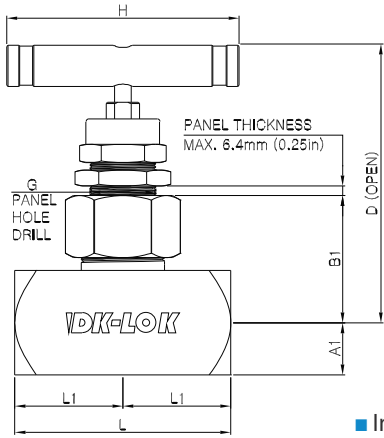

■ In-line pattern

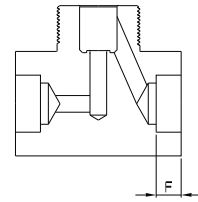

■ Socket weld end

Basic Ordering Number	End connections		Orifice mm (in.)	Cv	Dimensions, mm (inch)							
	Inlet	Outlet			L	L1	B1	A1	H	G	D	F
VH16A-	F2N-	1/8 Female NPT	4.0 (0.156)	0.35	57.2(2.25)	28.7(1.13)	34.0(1.34)	12.7(0.50)	63.5(2.50)	20.6(0.81)	77.2(3.04)	-
	F4N-	1/4 Female NPT			57.2(2.25)	28.7(1.13)	34.0(1.34)	12.7(0.50)	63.5(2.50)	20.6(0.81)	77.2(3.04)	-
	M4N-	1/4 Male NPT			57.2(2.25)	28.7(1.13)	34.0(1.34)	12.7(0.50)	63.5(2.50)	20.6(0.81)	77.2(3.04)	-
	MF4N-	1/4 Male to Female NPT			57.2(2.25)	28.7(1.13)	34.0(1.34)	12.7(0.50)	63.5(2.50)	20.6(0.81)	77.2(3.04)	-
	D4T-	1/4 DK-Lok			71.6(2.82)	35.8(1.41)	34.0(1.34)	12.7(0.50)	63.5(2.50)	20.6(0.81)	77.2(3.04)	-
	SW4T-	1/4 TSW			57.2(2.25)	28.7(1.13)	34.0(1.34)	12.7(0.50)	63.5(2.50)	20.6(0.81)	77.2(3.04)	7.1(0.28)
VH16B-	F4N-	1/4 Female NPT	6.4 (0.25)	0.86	79.5(3.13)	39.6(1.56)	46.0(1.81)	16.0(0.63)	88.9(3.50)	26.9(1.06)	108(4.27)	-
	F8N-	1/2 Female NPT			82.6(3.25)	41.4(1.63)	48.2(1.90)	19.8(0.78)	88.9(3.50)	26.9(1.06)	111(4.36)	-
	M8N-	1/2 Male NPT			79.5(3.13)	39.6(1.56)	46.0(1.81)	16.0(0.63)	88.9(3.50)	26.9(1.06)	108(4.27)	-
	MF8N-	1/2 Male to Female NPT			82.6(3.25)	41.4(1.63)	48.2(1.90)	19.8(0.78)	88.9(3.50)	26.9(1.06)	111(4.36)	-

All dimensions shown are for reference only and are subject to change. Dimensions with DK-Lok nuts are in finger-tight position.

- Non-rotating globe disc providing repetitive leak tight shut-off is standard.
- To order Angle Pattern, insert -A in the basic ordering number. Refer to the ordering information on page 4.

**Pressure-Temperature Ratings**

Ratings are based on valves with optional Grafoil packing.

**V16 Series**

ASME Class	2500		N/A
	Material Group	2.2	3.4
Material Name	SS316	Alloy 400	Alloy C-276
Temperature, °F (°C)	Working pressure, psig (bar)		
-65 (-53) to 100 (38)	6000 (413)	5000 (344)	6000 (413)
200 (93)	5160 (355)	4400 (303)	6000 (413)
300 (148)	4660 (321)	4120 (283)	6000 (413)
400 (204)	4280 (294)	3980 (274)	5880 (405)
500 (260)	3980 (274)	3960 (272)	5540 (381)
600 (315)	3760 (259)	-	5040 (347)
700 (371)	3600 (248)	-	4730 (325)
800 (426)	3460 (238)	-	4230 (291)
900 (482)	3280 (225)	-	3745 (258)
1000 (537)	3030 (208)	-	3030 (208)
1100 (593)	2685 (184)	-	2685 (184)
1200 (648)	1715 (118)	-	1545 (106)

**VH16 Series (High Pressure)**

ASME Class	N/A
Material Group	N/A
Material Name	SS316
Temperature, °F (°C)	Working pressure, psig (bar)
-65(-53) to 100 (38)	10000 (689)
200 (93)	9290 (640)
300 (148)	8390 (578)
400 (204)	7705 (530)
500 (260)	7165 (493)
600 (315)	6770 (466)
700 (371)	6480 (446)
800 (426)	6230 (429)
900 (482)	5905 (406)
1000 (537)	5450 (375)
1100 (593)	4835 (333)
1200 (648)	3085 (212)



**Pneumatic Actuators**

V16 series Pneumatic actuators are designed to actuate valves remotely.

V16A and V16B series are available to be equipped with pneumatic actuators in normally closed, normally open, and double-acting models.



**Dimensions**

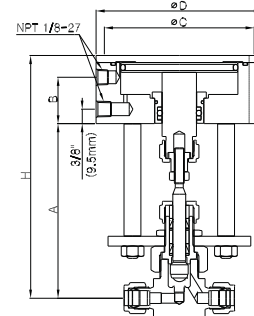
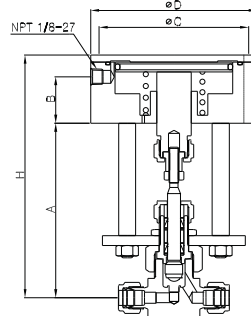
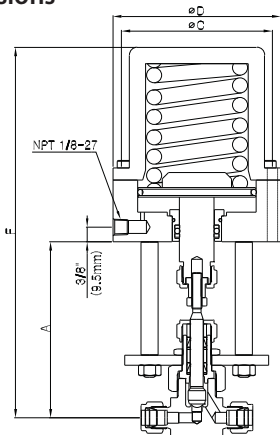

Valve Series	Dimensions in. (mm)					
	A	H	ØD	ØC	B	F
V16A	107 (4.22)	150 (5.91)	95.3 (3.75)	82.6 (3.25)	28.4 (1.12)	215 (8.47)
V16B	114 (4.47)	158 (6.22)	108 (4.25)	96.8 (3.81)	30.2 (1.19)	239 (9.41)

All dimensions are reference only and subject to change.

**Actuator Technical Data Pressure-Temperature Ratings**

Normally closed	Normally open and double acting
150 psig (10.3 bar) -20 to 300°F (-28 to 148°C)	150 psig (10.3 bar) -20 to 400°F (-28 to 204°C)

**Pneumatic Actuator Applicability**

V16A and V16B series valves with PTFE or PEEK packing are applicable to pneumatic actuator. Those valves with Grafoil packing are not applicable to pneumatic actuator.

**Operation Information**

Curve 1 - 6 indicate the minimum actuator pressure to open or close pneumatic actuators against system pressure.  
 To prolong valve life, actuators should be operated at minimum air actuator pressures.  
 Curves shown are based on packing bolt factory adjustment.  
 Packing bolt adjustment may be required to maintain the valve leak-tight.  
 If the packing bolt is over-tightened, the actuating pressure can not overcome the friction force between the over-tightened packing and the stem.  
 If the packing bolt is under-tightened for low system pressures, it may leak at high system pressures.  
 However, packing bolt torque must be sufficiently maintained to prevent packing from leakage.

**Normally Closed Actuators**

Adjusting the actuator stem drive nut affects the actuator inside the spring force. This will also have implications for other actuator components sequentially.

**Normally Open Actuators**

The stem orifice opens beyond the first open position depends on system pressure, flow characteristics of the fluid and valve packing nut adjustment.

**V16A Series**

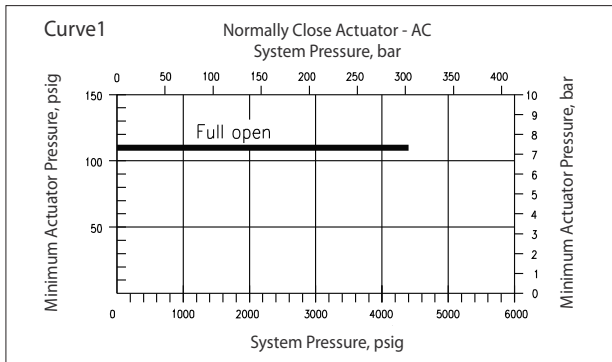

**V16B Series**

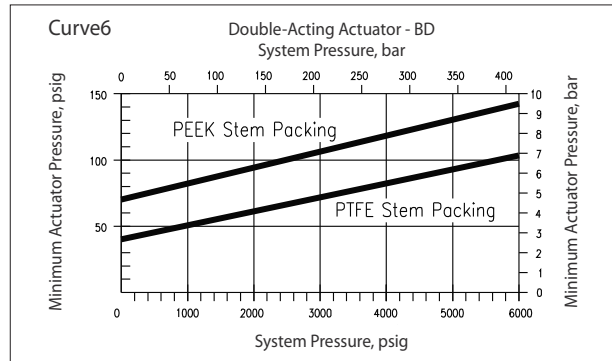
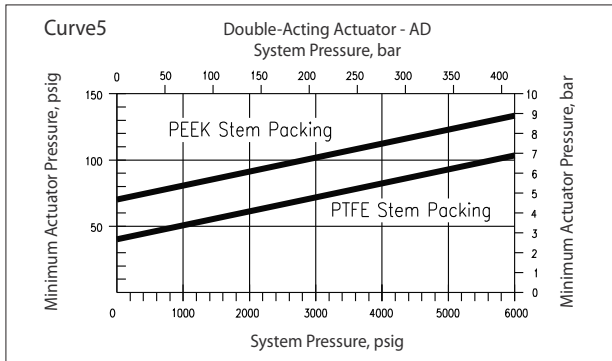
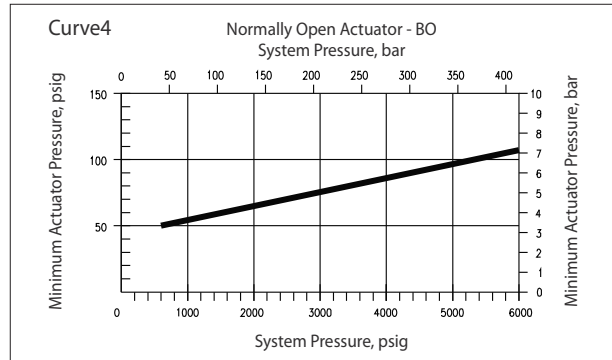
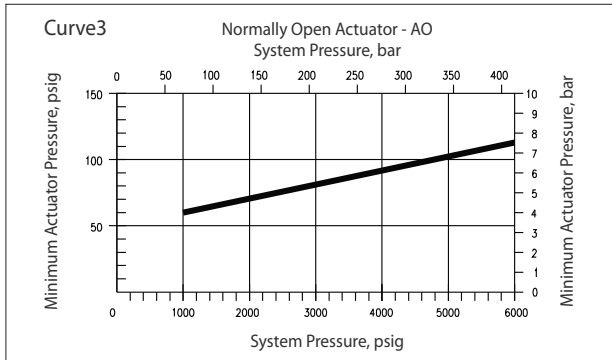
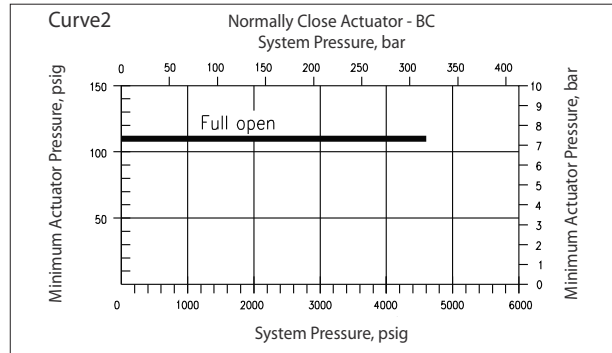

**Actuator Ordering Information**

To order valves with a pneumatic double acting actuator, insert the desired actuator designator from the chart in the valve ordering number.

Example: V16B-D6T-PK-B-**BD**-S

Valve Series	Pneumatic Actuator Designator		
	Normally Closed	Normally Open	Double Acting
V16A	AC	AO	AD
V16B	BC	BO	BD

**Safe Valve Selection**

The selection of a valve for any application or system design must be considered to ensure safe performance.

Valve function, valve rating, material compatibility, proper installation, operation and maintenance remain the sole responsibility of the system designer and the user. DK-Lok accepts no liability for any improper selection, installation, operation or maintenance.