

Wersja podstawowa

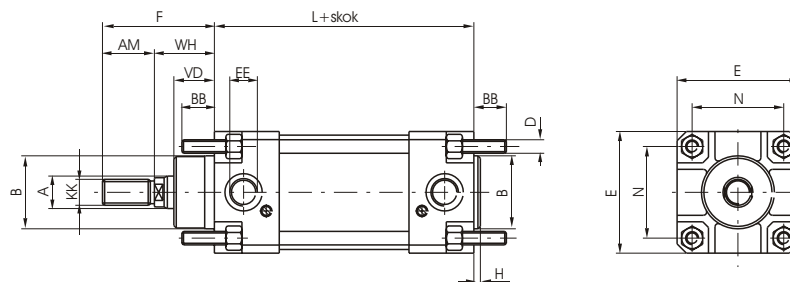

Kod zamówieniowy

1305.250.skok.01A (ISO)
tłok bez magnesu, tuleja aluminiowa
1308.250.skok.01A (ISO)
tłok magnetyczny, tuleja aluminiowa
wersja z uszczelnieniami z VITON'u:
-do kodu należy dodać literę "V"

| $\varnothing A$ | AM | $\varnothing B$ | BB | D | E | EE | F | H | KK | L | N | P | VD | WH |
|-----------------|----|-----------------|----|-----|-----|-----|-----|---|-------|-----|-----|----|----|-----|
| 50 | 84 | 90 | 50 | M20 | 270 | G1" | 189 | 4 | M42x2 | 200 | 220 | 54 | 65 | 105 |

Flansze mocujące : przednia i tylna

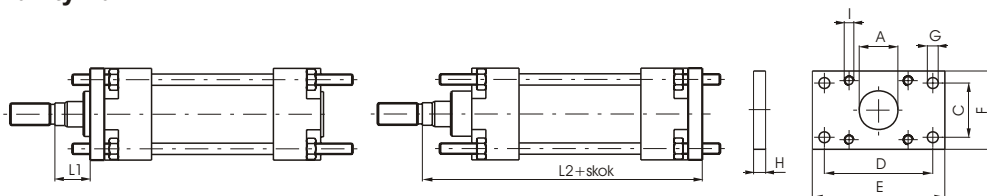

Kod zamówieniowy

1305.250.03F przednia
1305.250.04F tylna

| A (H11) | C(JS14) | D(JS14) | E | F | G (JS14) | H (JS14) | I | L1 | L2 | Waga g |
|---------|---------|---------|-----|-----|----------|----------|-----|----|-----|--------|
| 90 | 165 | 330 | 380 | 270 | 26 | 25 | M20 | 80 | 330 | 1.825 |

Kołnierz tylny, żeński, ze sworzniem

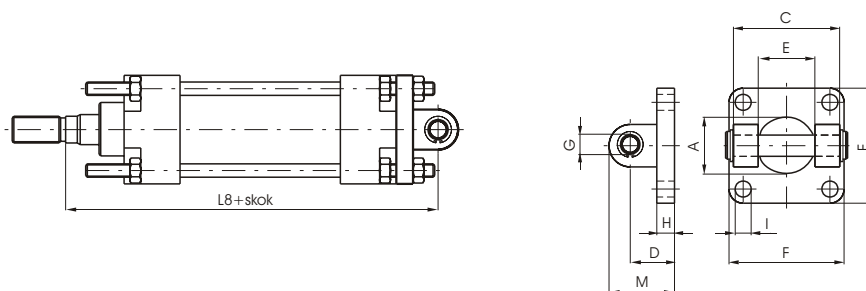

Kod zamówieniowy

1305.250.09F

| A | C(H14) | D(± 0.2) | E(H14) | F | G (H9) | H | I | M | L8 | Waga g |
|----|--------|----------------|--------|-----|--------|----|----|-----|-----|--------|
| 90 | 200 | 46 | 110 | 270 | 40 | 25 | 22 | 112 | 351 | 7.800 |

Kołnierz tylny, męski, ze sworzniem

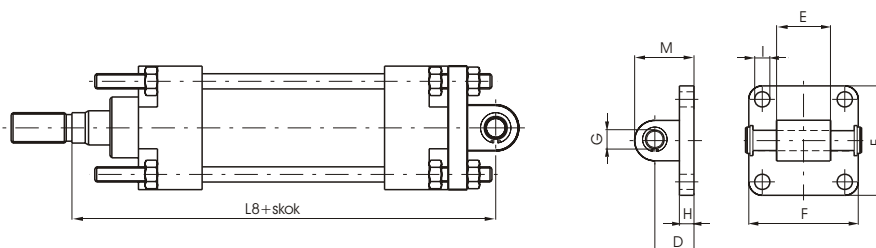

Kod zamówieniowy

1305.250.09/1F

| D(± 0.2) | E(H14) | F | G (H9) | H | I | M | L8 | Waga g |
|----------------|--------|-----|--------|----|----|-----|-----|--------|
| 46 | 110 | 270 | 40 | 25 | 22 | 112 | 351 | 8.300 |

Obejma wahlowa

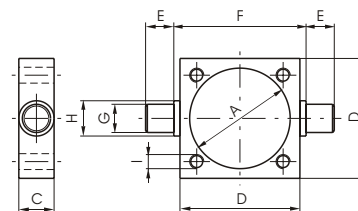
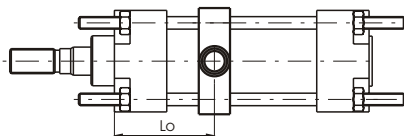

Kod zamówieniowy

1305.250.12F

| A | C | D | E(h14) | F(h14) | G (E2) | H | I | Lo min | Lo max | Waga g |
|-----|----|-----|--------|--------|--------|----|-----|--------|--------|--------|
| 267 | 50 | 296 | 40 | 320 | 40 | 60 | M20 | 83 | 117 | 1.300 |

Widelki z trzpieniem

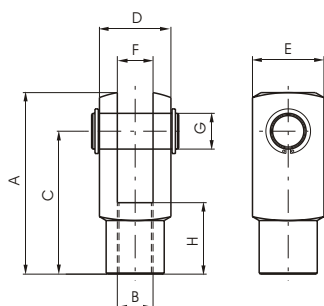

Kod zamówieniowy

1302.250.13F

| A | B(H6) | C | D | E | F(B12) | G(H9) | H | Waga g |
|-----|-------|-----|----|----|--------|-------|----|--------|
| 188 | M42X2 | 144 | 70 | 70 | 35 | 35 | 72 | 3.700 |

Nakrętka kontruująca tłoczisko

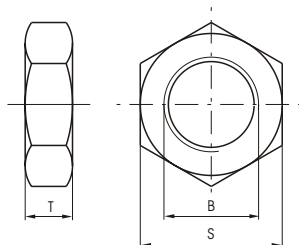

Kod zamówieniowy

1302.250.18F

| B | S | T | Waga g |
|-------|----|----|--------|
| M42x2 | 65 | 21 | 260 |